

STITCH TECH SOLUTION[®]
An innovative solution for stitch machineries

STITCH TECH SOLUTION

COMPANY PROFILE



+8801511255151

Hotline: +8801717955551

Technical Support: +8801747911151



faruk@stitchtechsolution.com

info@stitchtechsolution.com



Website

www.stitchtechsolution.com



Address: House # 12, Road #09, Sector #09,
Uttara Model Town, Dhaka-1230, Bangladesh





STITCH TECH SOLUTION®
An innovative solution for stitch machineries

Table of Contents

| | |
|---------------------------|---------|
| About us | 03 |
| Mission Vision | 04 |
| Core Values | 05 |
| Messages | 06 – 08 |
| Products & Services | 09 – 11 |
| Brands | 12 |
| What we supply | 13 – 17 |
| Join Our Donation Program | 18 |
| Why Choose Us | 19 |
| Our Certificates | 20 – 22 |
| Valued Clients | 23 |



+8801511255151

Hotline: +8801717955551

Technical Support: +8801747911151



faruk@stitchtechsolution.com

info@stitchtechsolution.com



Website

www.stitchtechsolution.com



Address: House # 12, Road #09, Sector #09,
Uttara Model Town, Dhaka-1230, Bangladesh





ABOUT US

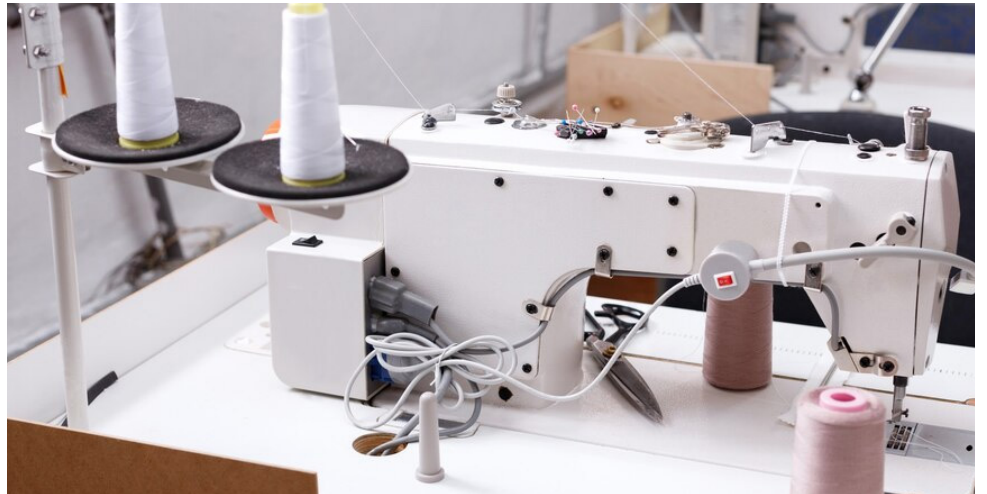

Stitch Tech Solution is a trusted name in the sewing industry, offering sewing machines, spare parts, circuit boards, servicing, sales, and supply solutions. With years of experience, we have built a reputation for quality products and exceptional customer service.

We support businesses in garments industries, providing industrial and domestic sewing machines, electronic components, and expert servicing to keep operations running smoothly.

Committed to innovation, reliability, and customer satisfaction, we stay updated with the latest technology to deliver efficient and durable solutions. With a customer-first approach and competitive pricing, Stitch Tech Solution is your trusted partner for all sewing machine needs.

Our team of experts ensures that every product and service meets high industry standards, helping businesses reduce downtime and improve productivity. Whether you're looking for a new machine, spare parts, or professional maintenance, we provide tailored solutions to match your specific requirements.



MISSION

To provide high-quality sewing machines, spare parts, and expert servicing, ensuring seamless production and efficiency for businesses in the garments, textile, leather, and upholstery industries.



VISION

To be a leading and trusted provider of sewing solutions, delivering innovative, reliable, and customer-focused products that drive long-term success.

Our Commitment

At Stitch Tech Solution, we are committed to delivering high-quality sewing machines, spare parts, and expert services that keep your business running smoothly. Our focus is on innovation, reliability, and customer satisfaction, ensuring you get the best products and support.

We prioritize efficiency, affordability, and long-term partnerships, providing tailored solutions to meet your unique needs. With a customer-first approach and industry expertise, we stand by our promise to offer durable, high-performance solutions that help you achieve success.

CORE VALUES



Quality First – We ensure top-notch products and services that meet the highest industry standards.



A

Innovation & Technology – We stay updated with the latest advancements to provide cutting-edge sewing solutions.



B

Customer Commitment – We prioritize customer satisfaction with reliable support and tailored solutions.



Reliability & Efficiency – We deliver durable products and quick, effective solutions to minimize downtime.



C

Integrity & Transparency – We believe in honesty, fairness, and ethical business practices.



D

Continuous Improvement – We strive for excellence by constantly improving our products, services, and expertise.



E

Affordability – We offer competitive pricing without compromising on quality.



F

G

Sustainable Growth – We focus on long-term success by building strong relationships with our clients and partners.



H

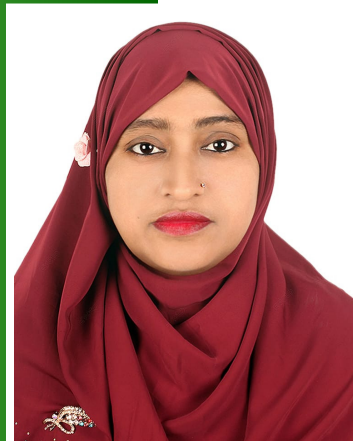

MESSAGE FROM CHAIRMAN

At Stitch Tech Solution, our journey has always been driven by a passion for excellence and a commitment to serving the garments, textile, leather, and upholstery industries with the best sewing machines, spare parts, and technical solutions.

In today's fast-paced world, efficiency and quality are key to success. That's why we focus on providing reliable products, expert servicing, and innovative solutions to help businesses thrive. Our dedication to customer satisfaction, integrity, and continuous improvement ensures that we deliver nothing but the best.

We deeply appreciate the trust and support of our clients and partners. As we move forward, Stitch Tech Solution will continue to evolve, embracing new technologies and expanding our services to meet your growing needs.

Our goal is not just to be a supplier but a trusted partner in your success. We believe in building long-term relationships and providing solutions that help businesses grow. Whether you are looking for new equipment, spare parts, or expert servicing, our team is always ready to assist you with dedication and expertise.

Thank you for being a part of our journey. We look forward to building a strong and successful future together.

Best Regards

Reshma Islam

Chairman



MESSAGE FROM MANAGING DIRECTOR

At Stitch Tech Solution, we take pride in being a reliable partner for businesses across the garments, textile, leather, and upholstery industries. Our commitment is to provide quality sewing machines, spare parts, circuit boards, and expert servicing that empower businesses to achieve seamless operations.

We believe that the foundation of success lies in trust, reliability, and innovation. Our team is dedicated to ensuring that every product and service we offer contributes to your success. From high-performance equipment to ongoing support, we strive to exceed expectations and build long-lasting relationships with our clients.

As we continue to grow, our focus remains on providing cutting-edge solutions, backed by our extensive industry knowledge and customer-first approach. We are here to serve you with the best in the industry, making sure that your operations are efficient, cost-effective, and always moving forward.

Thank you for choosing Stitch Tech Solution. We look forward to supporting your business and helping you reach new heights of success.

Best Regards

Md. Farukul Islam Faruk

Managing Director



MESSAGE FROM THE DIRECTOR

At **Stitch Tech Solution**, our mission is to be a trusted partner in the garments and textile industries by providing high-quality sewing machines, spare parts, and exceptional service. We believe that innovation, reliability, and customer satisfaction are the key pillars of success. Our commitment extends beyond supplying products—we strive to deliver comprehensive solutions that enhance efficiency, boost productivity, and drive long-term business growth.

From the very beginning, we have focused on offering only the best brands and ensuring that our products meet **international quality standards**. Our expert servicing team is always ready to provide fast and professional support, ensuring smooth and uninterrupted operations for our clients. Additionally, our reliable supply chain guarantees timely delivery, helping businesses meet their production goals without delay.

As we continue to grow, we remain dedicated to upholding our values of **trust, excellence, and integrity**. Our success is built on the strong relationships we have with our clients and partners, and we are deeply grateful for their continuous support. Moving forward, we are excited to introduce even more advanced solutions, ensuring that **Stitch Tech Solution** remains a leader in the industry.

We look forward to serving you with even better innovations in the future.

Best Regards

MYMON ARA HOSSAIN SALENA

Director



PRODUCTS & SERVICES

At Stitch Tech Solution, we offer a comprehensive range of services to support your sewing and machinery needs, ensuring that your operations run smoothly and efficiently. Our services are designed to meet the specific requirements of businesses in the garments industries.



Sewing Machine Sales

We provide a wide selection of industrial and domestic sewing machines to suit various production needs. Whether you need a high-speed machine or specialized equipment, we have the right solution for you.



Spare Parts & Accessories

We offer an extensive inventory of sewing machine spare parts, including needles, bobbins, presser feet, and circuit boards. All parts are sourced from trusted manufacturers to ensure quality and durability.



Expert Servicing & Repairs

Our team of skilled technicians provides maintenance and repair services for all types of sewing machines. We ensure that your machines are operating at peak performance, minimizing downtime and maximizing productivity.



PRODUCTS & SERVICES



Machine Installation & Setup

We offer professional installation and setup services for newly purchased sewing machines, ensuring they are ready for immediate use and properly calibrated to meet your production needs.



Technical Support & Consultation

We provide expert technical support and consultation to help businesses select the right equipment, optimize their operations, and solve any machine-related challenges.

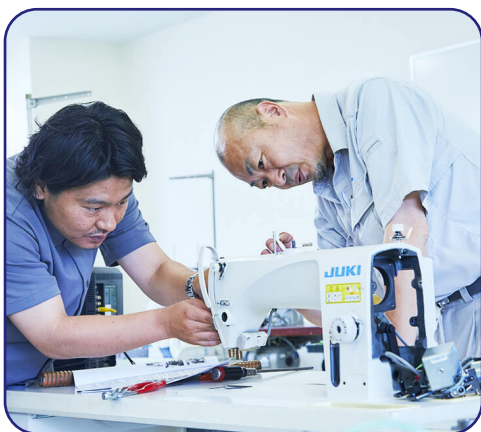

Custom Solutions

We understand that every business has unique needs. That's why we offer custom solutions, tailoring our products and services to meet specific requirements, from specialized machines to unique spare parts.

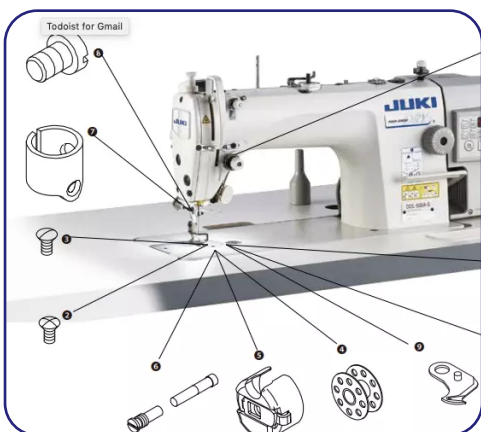

Product Sourcing & Supply

We facilitate sourcing and supply services for businesses that need specific machines or parts not readily available in the market, ensuring you get what you need when you need it.



Training & Maintenance Programs

We offer training and ongoing maintenance programs to help your team operate machines efficiently and keep them in excellent condition, reducing long-term repair costs and extending the lifespan of your equipment.



Machine Upgrades & Modifications

We specialize in upgrading and modifying existing sewing machines to improve their performance and efficiency. Whether it's adding new features or enhancing capabilities, we provide tailored solutions that extend the life of your machines.



Emergency Repair Services

We understand that downtime can be costly. Our emergency repair services ensure quick response and repair, minimizing disruptions to your production and getting your machines back to work as soon as possible.



Spare Part Sourcing

In addition to our in-house stock, we also offer spare part sourcing services for rare or hard-to-find components, ensuring that your machines are fully equipped for peak performance.

BRANDS



At Stitch Tech Solution, we partner with leading global brands to provide our customers with top-quality sewing machines, spare parts, and accessories. We carefully select our brands based on their reputation for innovation, durability, and performance, ensuring that our clients receive the best products available in the industry.

JUKI

 **FDM**[®]

brother[®]

 **HO HSING**

ISM[®]

JACK
China No.1

Ijamoto[®]

KANSAI
SPECIAL[®]

ZOJE



WHAT WE SUPPLY

At Stitch Tech Solution, we provide high-quality sewing machines and accessories to meet the diverse needs of garment factories. Our products ensure efficiency, durability, and precision for every stitching requirement.



WHAT WE SUPPLY

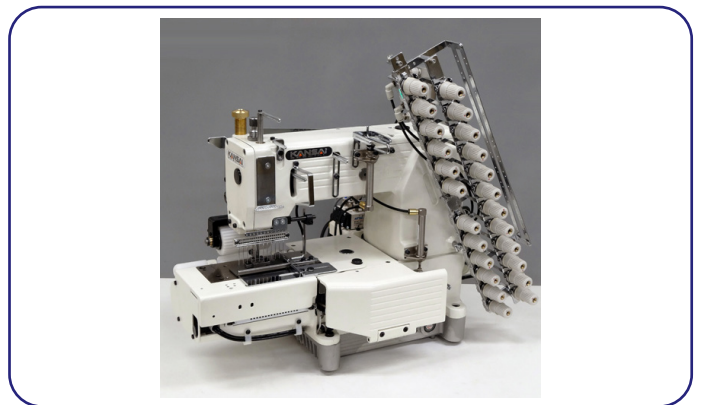
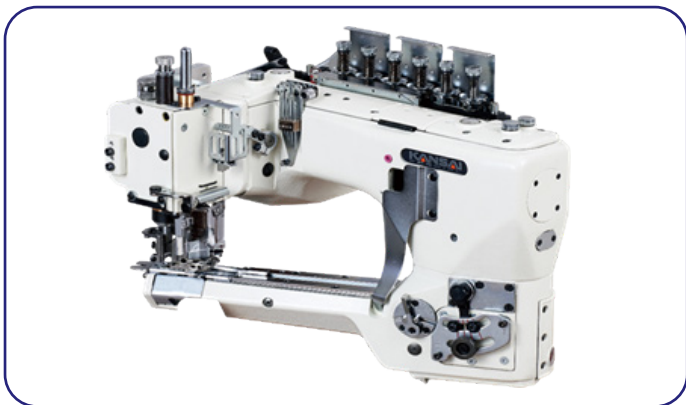
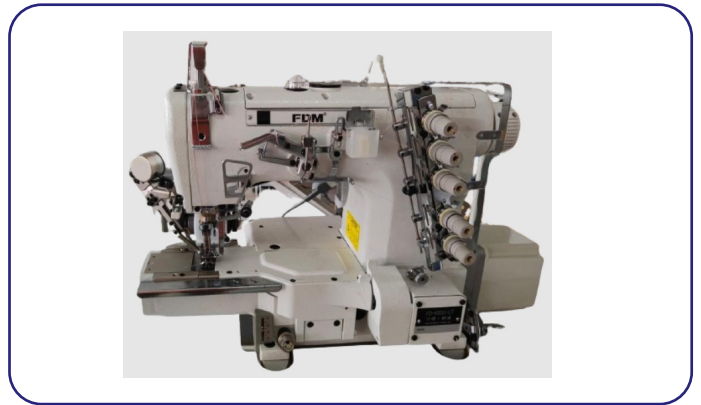

WHAT WE SUPPLY

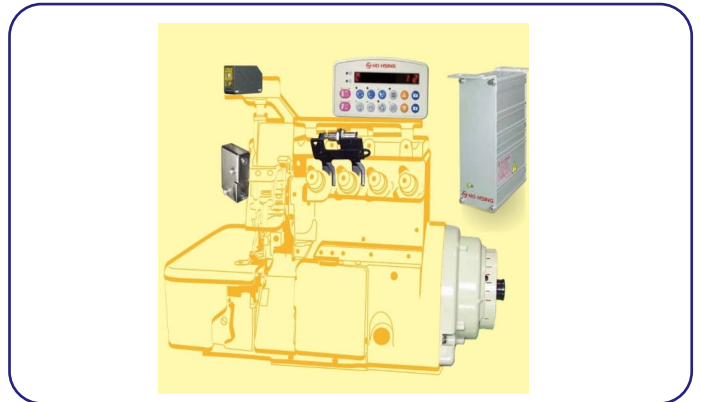

WHAT WE SUPPLY



WHAT WE SUPPLY



JOIN OUR DONATION PROGRAM



At Stitch Tech Solution, we believe that business should be more than just transactions—it should create a positive impact. That's why we have launched our Donation Program, where every purchase contributes to a greater cause.

For every sewing machine sold, we donate 2% of the sales to our Donation Fund, which supports charitable initiatives, empowering communities and individuals in need. Our goal is to promote the art of sewing while making a meaningful difference in people's lives.

By choosing Stitch Tech Solution, you're not just investing in high-quality sewing machines, spare parts, and services—you're also helping to create opportunities, support local communities, and spread hope.



WHY CHOOSE US?



At Stitch Tech Solution, we are more than just a supplier – we are your trusted partner in the sewing industry. Here's why businesses choose us:

High-Quality Products – We offer top-brand sewing machines, spare parts, and accessories to ensure durability and efficiency.

Expert Technical Support – Our skilled team provides professional servicing, repairs, and maintenance to keep your machines running smoothly.

Wide Product Range – From industrial to domestic machines, circuit boards to accessories, we have everything you need under one roof.

Competitive Pricing – Get the best value for your investment with high-quality products at affordable prices.

Reliable After-Sales Service – We stand by our products with dedicated customer support and expert troubleshooting.

Customization & Special Orders – Need something specific? We offer customized solutions to meet unique business needs.

Fast & Secure Delivery – We ensure quick and safe delivery of machines and parts, minimizing downtime for your business.

Trusted Industry Experience – With years of expertise, we understand your needs and provide tailored solutions for maximum productivity.

When you choose Stitch Tech Solution, you're choosing quality, reliability, and excellence in the sewing industry.

At Stitch Tech Solution, we are a legally registered and compliant business, holding all necessary licenses to operate in the sewing machine and parts industry. Our trade license is issued by the relevant authorities, ensuring that we adhere to all local laws and regulations.

ঢাকা উত্তর সিটি কর্পোরেশন

www.dncc.gov.bd



লাইসেন্স ইস্যুর বিবরণ

ই-ট্রেড লাইসেন্স

ইস্যুর তারিখ : 03/02/2025

ইস্যুর সময় : 09:07:21

লাইসেন্স নং : TRAD/DNCC/017390/2023

স্থানীয় সরকার (সিটি কর্পোরেশন) আইন, ২০০৯ (২০০৯ সনের ৬০ নং আইন) এর ধারা ৮৪-তে প্রদত্ত ক্ষমতাবলে সরকার প্রণীত আদর্শ কর তফসিল, ২০১৬ এর ১০ অনুচ্ছেদ অনুযায়ী ব্যবসা, বৃত্তি, পেশা বা শিল্প প্রতিষ্ঠানের উপর আরোপিত কর আদায়ের লক্ষ্যে নিম্নে বর্ণিত ব্যক্তি/প্রতিষ্ঠানের আনুকূলে অত্র ট্রেড লাইসেন্সটি ইস্যু করা হলো।

| | | | |
|---------------------------------------|---|----------------------------|-----------------------------|
| ১। ব্যবসা প্রতিষ্ঠানের নাম | : সিচ টেক সলিউশন | | |
| ২। ব্যবসা প্রতিষ্ঠানের মালিকের নাম | : মোসাঃ রেশমা আক্তার | | |
| ৩। পিতা / স্বামীর নাম | : নরুল হক | | |
| ৪। মাতার নাম | : মোসাঃ ফিরোজা বেগম | | |
| ৫। ব্যবসার প্রকৃতি | : অন্যান্য - একক | | |
| ৬। ব্যবসার ধরণ | : আমদানীকারক/ইলেকট্রনিক্স পন্য বিক্রেতা, ইলেকট্রিক সামগ্রী মেরামত (হাতে), সরবরাহকারী (দাহ্য পদার্থ ও ক্যামিকেল ব্যাতিত) | | |
| ৭। ব্যবসা প্রতিষ্ঠানের ঠিকানা | : প্লট-২১, আকাশ প্লাজা, ৩য় তলা, সেক্টর-০৯, উত্তরা, ঢাকা-১২৩০ | | |
| ৮। অঞ্চল/ডিএনসিসি'র নিজস্ব মার্কেট | : ১ উত্তরা | ওয়ার্ড: | ১ |
| ৯। এনআইডি/পাসপোর্ট/জন্ম নিবন্ধন নং | : 8691212560 | টিআইএন/বিআইএন নং: | 310922376122 |
| মোবাইল নম্বর | : +880 1717955551 | ই-মেইল: | info@stitchtechsolution.com |
| ১০। অর্থ বছর | : ২০২৪-২০২৫ (নবায়নকৃত) | ব্যবসা শুরুর তারিখ: | ০১/০৯/২০২৩ |
| ১১। মালিকের বর্তমান ঠিকানা | | মালিকের স্থায়ী ঠিকানা | |
| হোল্ডিং নং | : ১২ | হোল্ডিং নং | : |
| রোড নং | : ০৯ | রোড নং | : ০৬ |
| গ্রাম / মহল্লা | : সেক্টর-০৯ | গ্রাম / মহল্লা | : পূর্ব রসুলপুর |
| পোস্ট কোড | : ১২৩০ | পোস্ট কোড | : আশরাফাবাদ |
| থানা | : উত্তরা | থানা | : কামরাঙ্গীরচর |
| জেলা | : ঢাকা | জেলা | : ঢাকা |
| বিভাগ | : ঢাকা | বিভাগ | : ঢাকা |
| ১২। আদর্শ কর তফসিল, ২০১৬ এর ক্রমিক নং | : | | |
| ১৩। ট্রেড লাইসেন্স ফি (নতুন/নবায়ন) | | | |
| লাইসেন্স/নবায়ন ফি | : ২৫০০ | সাইনবোর্ড কর (পরিচিতিমূলক) | : ৪৮০ |
| সারচার্জ | : ১২৫০ | ভ্যাট | : ৬৩৪ |
| আয়কর / উৎসেকর | : ৩০০০ | বই মূল্য | : ২৭০ |
| বকেয়া () | : ০ | ফর্ম ফি | : ০.০০ |
| সংশোধনী ফি | : ৫১১৮.০০ | অন্যান্য ফি | : ৫০০.০০ |
| | | সর্বমোট | : ১৩৭৫৩.০০ |

অত্র ট্রেড লাইসেন্স এর মেয়াদ ৩০ শে জুন, ২০২৫ পর্যন্ত

লাইসেন্স ও বিজ্ঞাপন সুপারভাইজার



কর কর্মকর্তা

TIN (TAXPAYER IDENTIFICATION NUMBER)



At Stitch Tech Solution, we are fully registered with the tax authorities and possess a valid TIN (Taxpayer Identification Number). This ensures that we comply with all tax regulations and contribute to the local economy.



Government of the People's Republic of Bangladesh
National Board of Revenue
Taxpayer's Identification Number (TIN) Certificate
TIN : 310922376122

This is to Certify that **Mst Rhasima** is a Registered Taxpayer of National Board of Revenue under the jurisdiction of **Taxes Circle-086 , Taxes Zone 04, Dhaka.**

Taxpayer's Particulars :

- 1) Name : **Mst Rhasima**
- 2) Father's Name : **Nurul Hoq**
- 3) Mother's Name : **Firoza**
- 4.a) Current Address : **Purba Rasulpur, Road - 06, Ashrafabad, Zone-03, Kamrangirchar, Dhaka**
- 4.b) Permanent Address : **Purba Rasulpur, Road - 06, Ashrafabad, Kamrangirchar, Zone-03, Kamrangirchar, Dhaka**
- 5) Previous TIN : **Not Applicable**
- 6) Status : **Individual**

Date : May 06, 2023

Please Note:

1. A Taxpayer is liable to file the Return of Income under section 75 of the Income Tax Ordinance, 1984.
2. Failure to file Return of Income under section 75 is liable to-
 - (a) Penalty under section 124; and
 - (b) Prosecution under section 164 of the Income Tax Ordinance, 1984.



Deputy Commissioner of Taxes
Taxes Circle-086
Taxes Zone 04, Dhaka
Address : Tapa Complex, 169/Kha, Shahid Saiyed Nazrul Islam Shoroni, Purana Polton, Dhaka. Phone : 223358743

N. B. This is a system generated certificate and requires no manual signature.

BIN (BUSINESS IDENTIFICATION NUMBER)



At Stitch Tech Solution, we are registered with the relevant tax authorities and hold a valid BIN (Business Identification Number). This number is essential for conducting business operations legally and for tax reporting purposes.



Government of the People's Republic of Bangladesh
National Board of Revenue

Mushak-2.3

Customs, Excise and VAT Commissionerate, Dhaka (North)
Tongi Division

Value Added Tax Registration Certificate

This is to certify that the person whose details are given below is registered under Value Added Tax and Supplementary Duty Act, 2012 (Act No. 47 of 2012)

BIN : 006640983-0102

| | |
|---------------------------------|---|
| Name of the Entity | : STITCH TECH SOLUTION |
| Trading Brand Name | : Stitch Tech Solution |
| Old BIN | : N/A |
| e-TIN | : 310922376122 |
| Address | : Plot-21, Akash Plaza, 2nd Floor, Sector-09, Uttara, Dhaka-1230; Uttara PS; Dhaka-1230; Bangladesh |
| Issue Date | : 26/01/2025 |
| Effective Date | : 01/2025 |
| Type of Ownership | : Proprietorship |
| Major Area of Economic Activity | : Services, Retail/Wholesale Trading |



This is a system generated certificate and doesn't require any signature



OUR VALUED CLIENTS

At Stitch Tech Solution, we take pride in serving a diverse range of clients across the garments, textile, leather, and upholstery industries. Our commitment to quality products, exceptional service, and reliable support has earned us the trust of businesses both large and small.





Contact us



+8801511255151

Hotline: +8801717955551

Technical Support: +8801747911151



faruk@stitchtechsolution.com

info@stitchtechsolution.com



Website

www.stitchtechsolution.com



Address: House # 12, Road #09, Sector #09,
Uttara Model Town, Dhaka-1230, Bangladesh

